

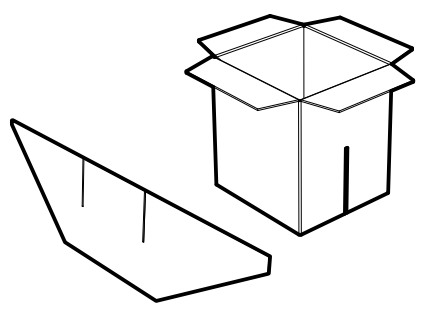

# R1 ULTIMATE COMPATIBILITY TESTER

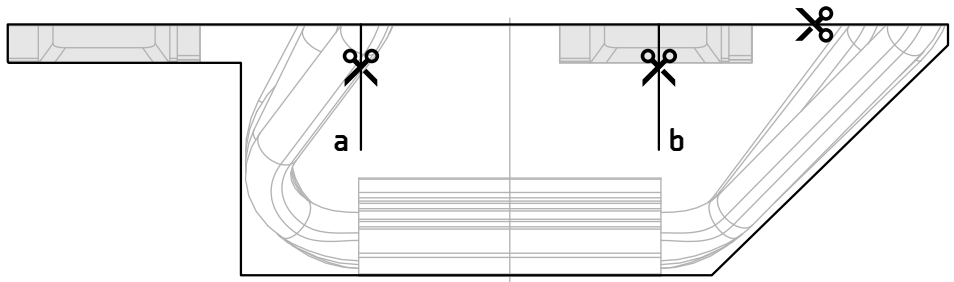
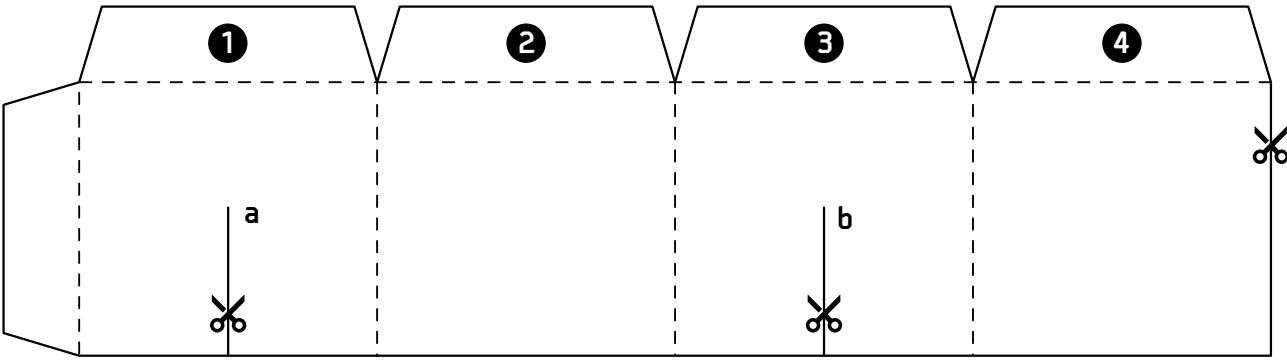
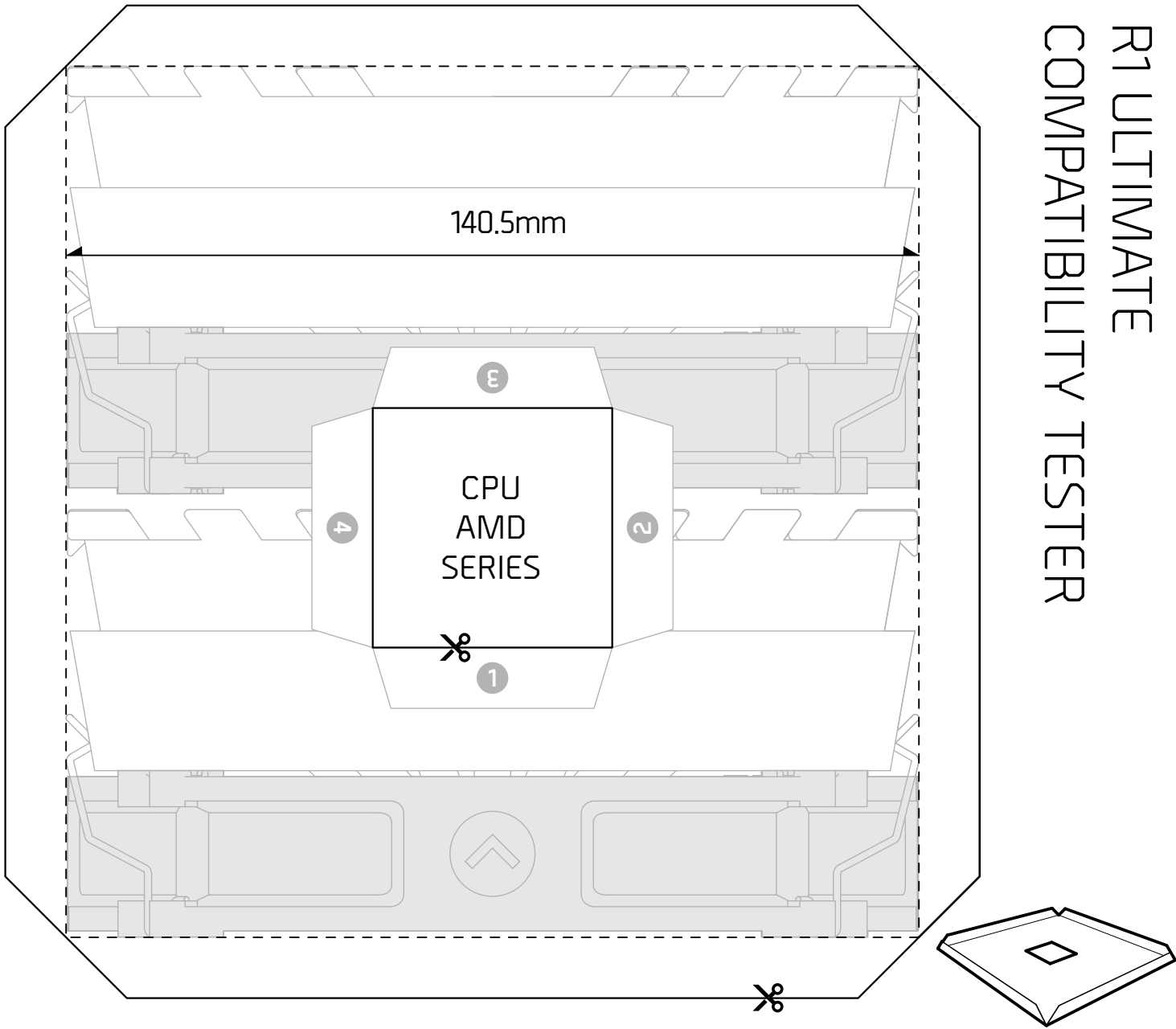
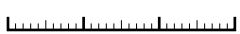
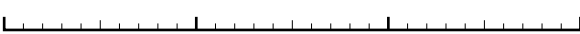

Scale Check Zone :  

 CHECK IF YOUR PRINT IS TRUE TO SIZE WITH THE SCALE CHECK. WITH A RULER, CHECK IF THE TWO LINES ARE 3CM AND 3 INCHES AS INDICATED.