

R1 UNIVERSAL COMPATIBILITY TESTER

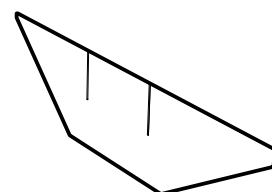

Scale Check Zone :  3 cm  3 inch

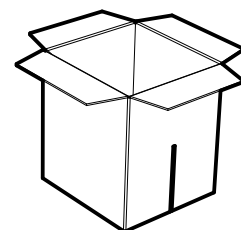
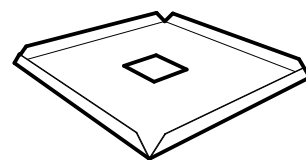
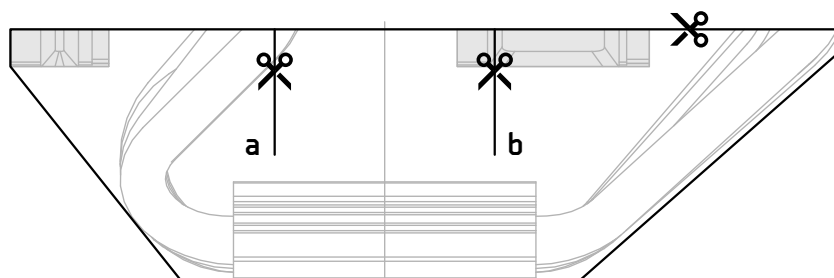
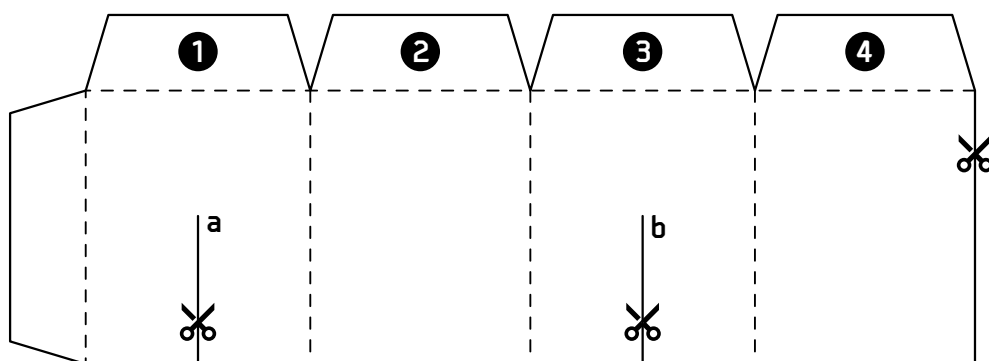
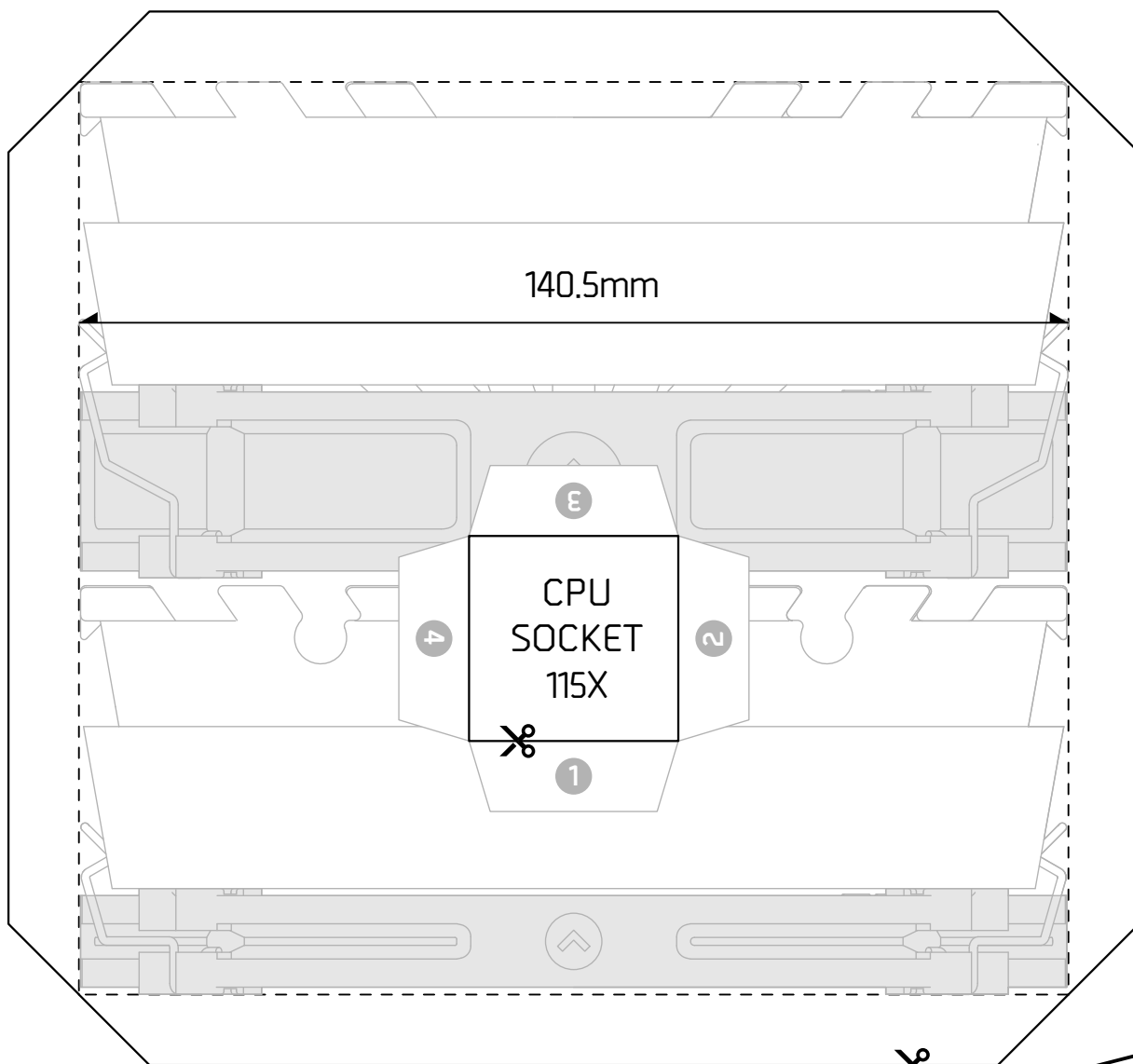

CHECK IF YOUR PRINT IS TRUE TO SIZE WITH THE SCALE CHECK. WITH A RULER, CHECK IF THE TWO LINES ARE 3CM AND 3 INCHES AS INDICATED.

R1 UNIVERSAL COMPATIBILITY TESTER

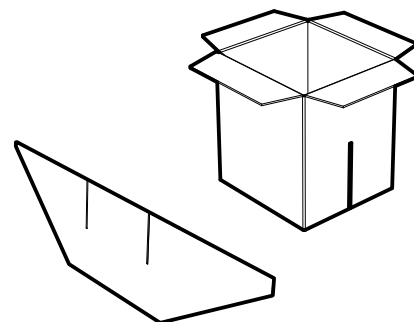
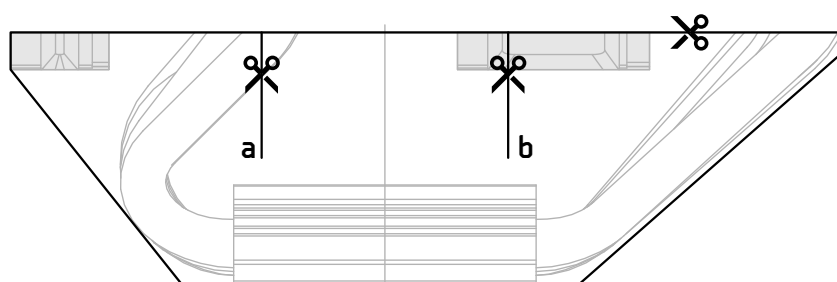
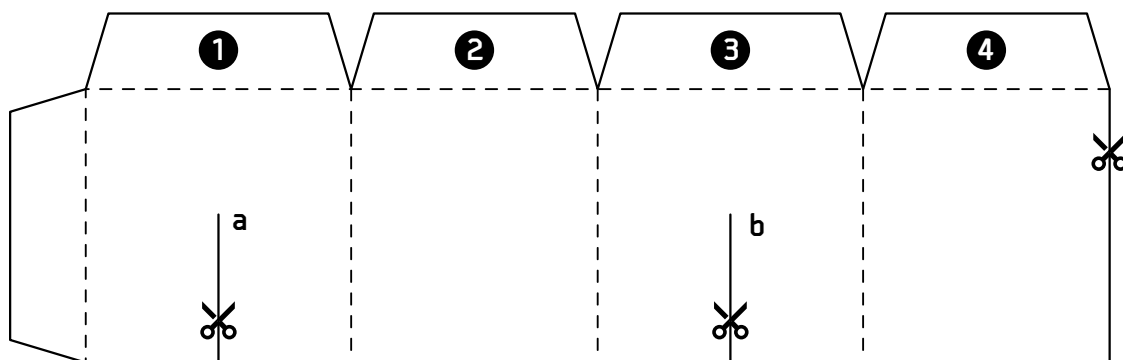
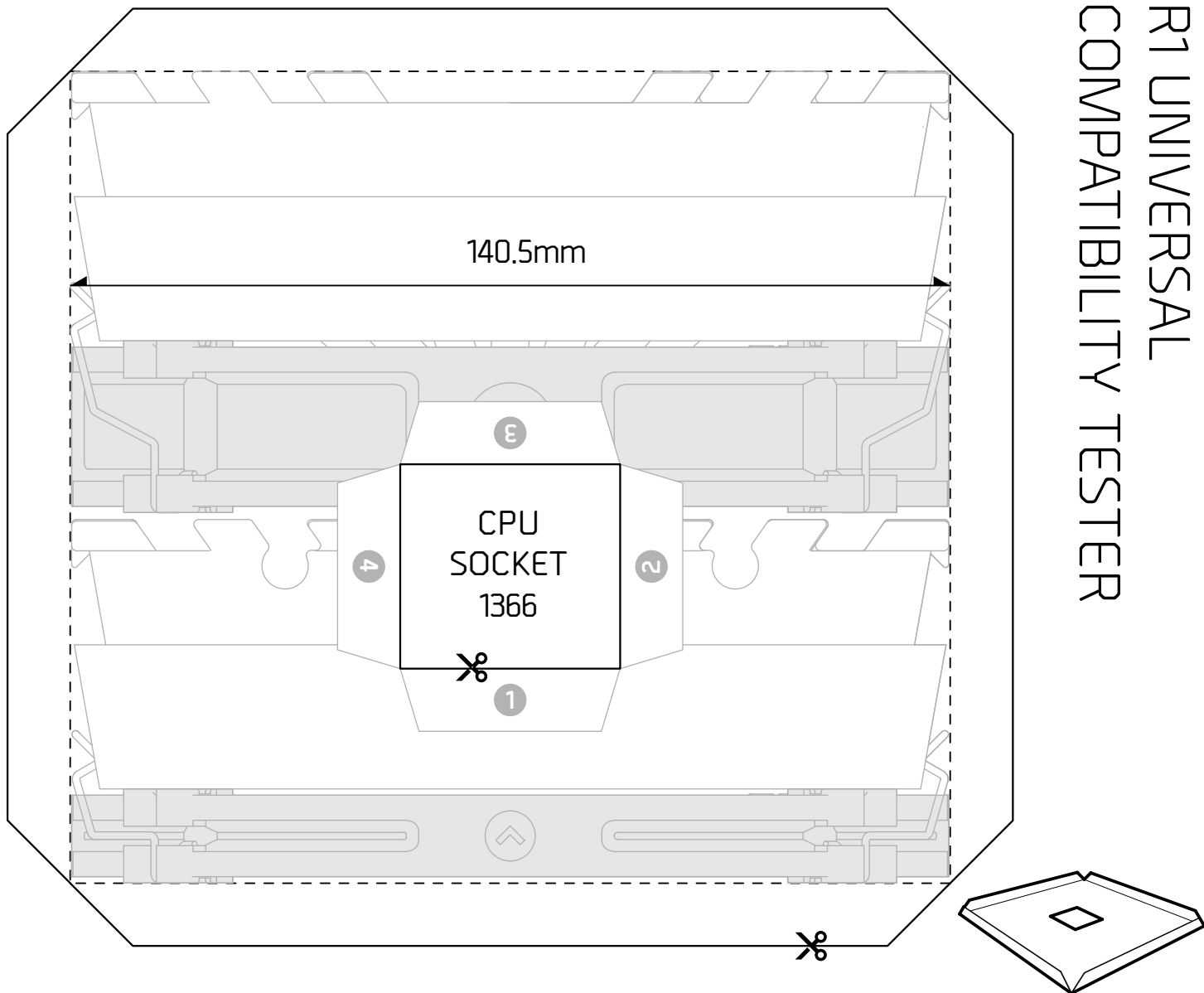

Scale Check Zone : 3 cm 3 inch



CHECK IF YOUR PRINT IS TRUE TO SIZE WITH THE SCALE CHECK. WITH A RULER, CHECK IF THE TWO LINES ARE 3CM AND 3 INCHES AS INDICATED.

R1 UNIVERSAL COMPATIBILITY TESTER

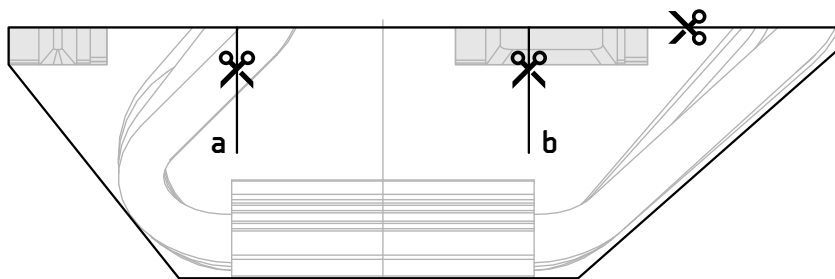
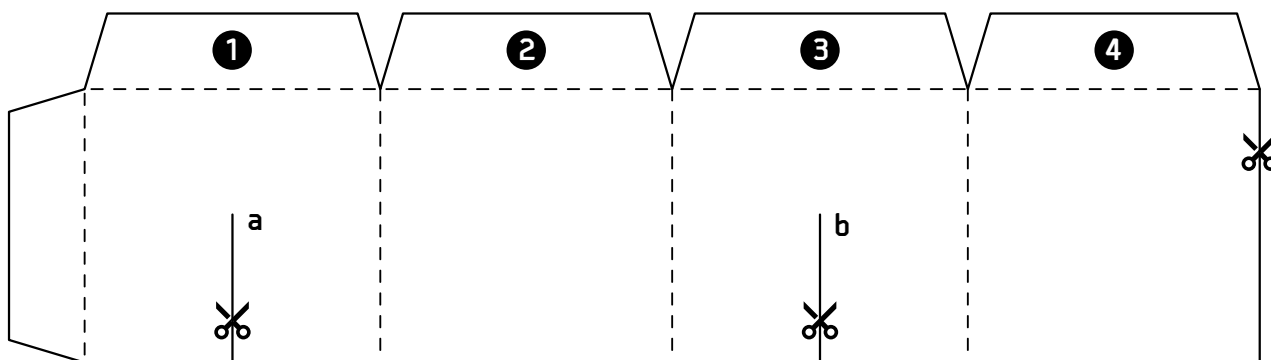
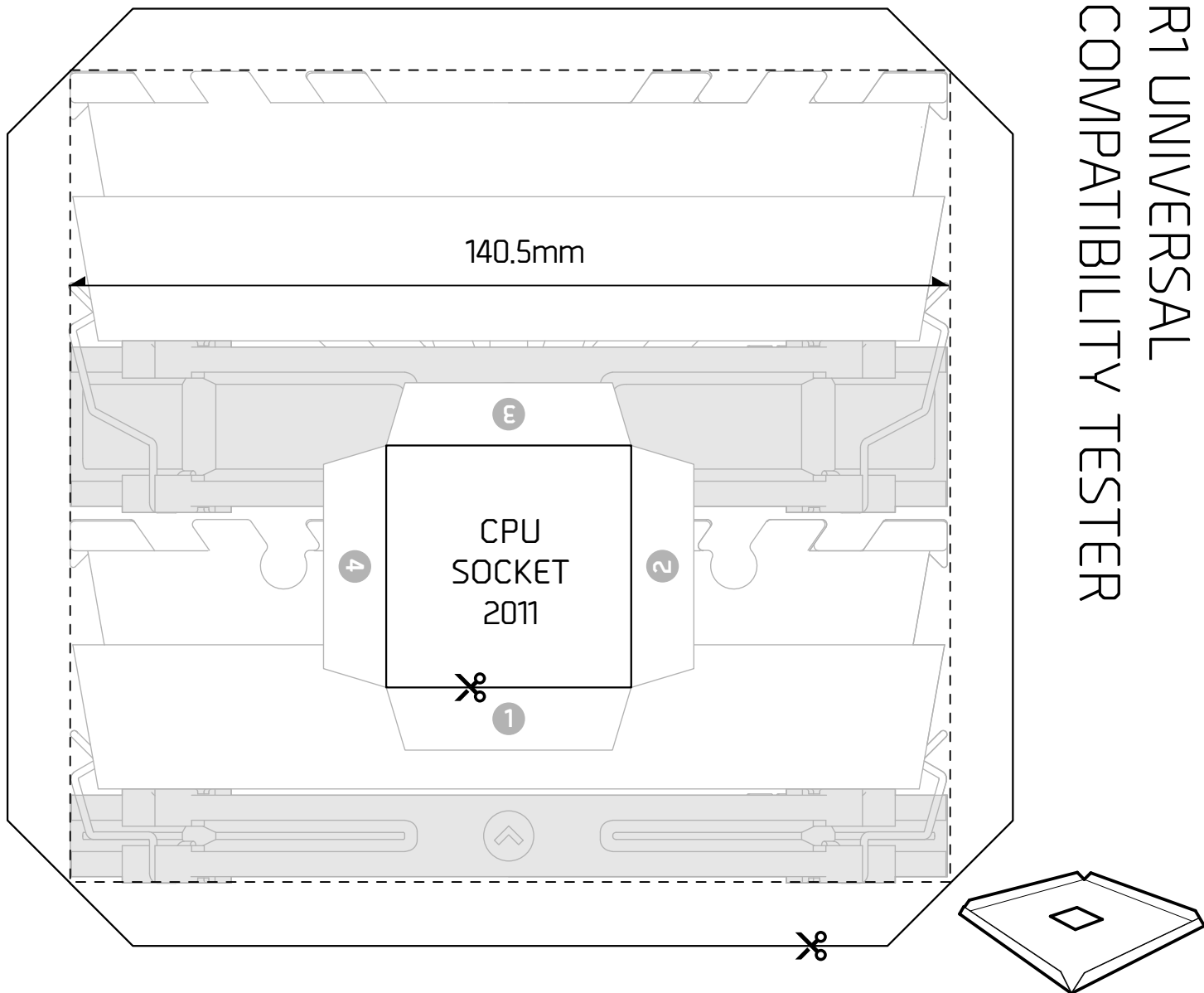

Scale Check Zone : 3 cm 3 inch



CHECK IF YOUR PRINT IS TRUE TO SIZE WITH THE SCALE CHECK. WITH A RULER, CHECK IF THE TWO LINES ARE 3CM AND 3 INCHES AS INDICATED.

R1 UNIVERSAL COMPATIBILITY TESTER

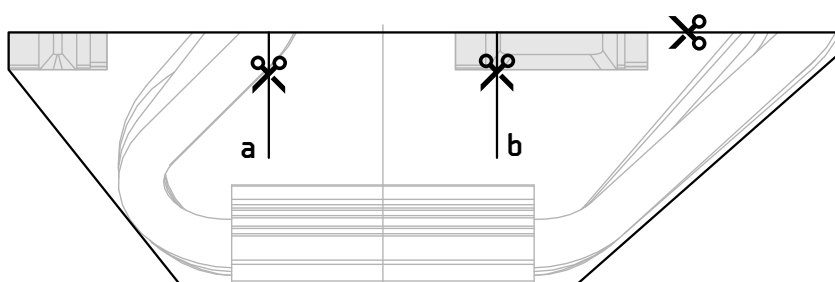
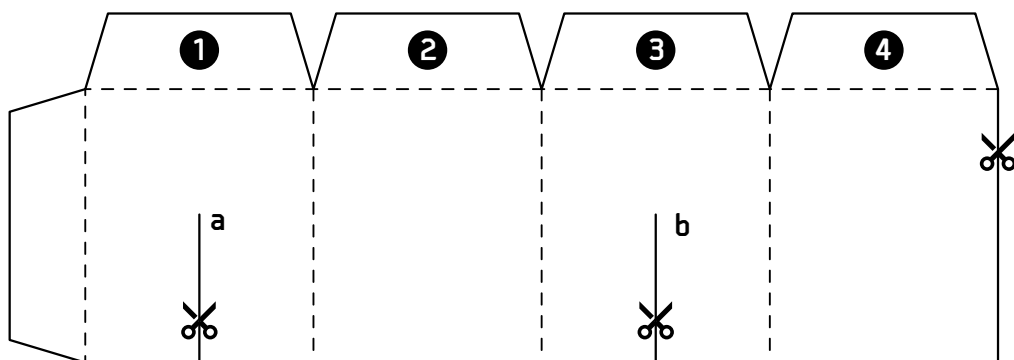
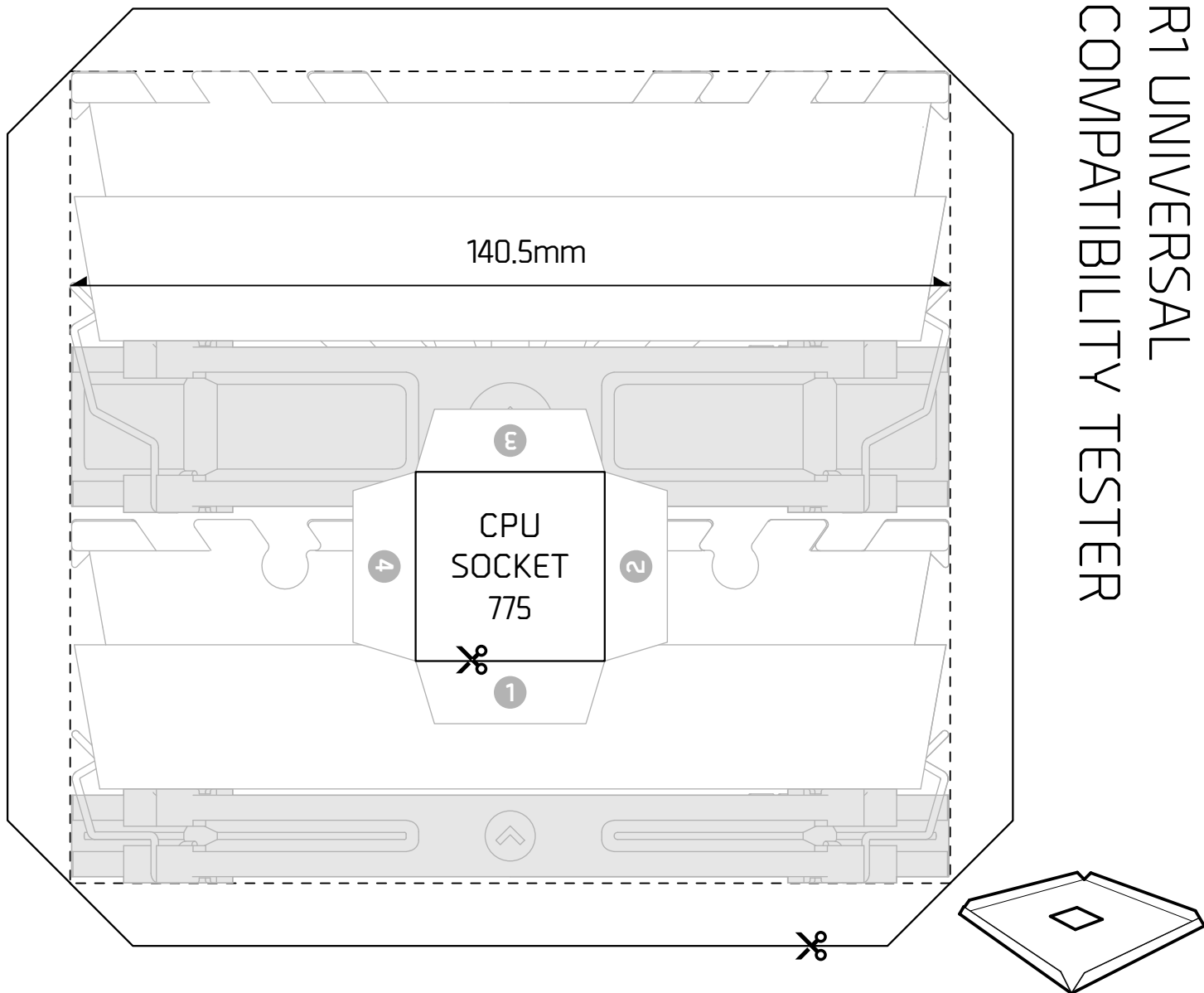



Scale Check Zone : 3 cm 3 inch

CHECK IF YOUR PRINT IS TRUE TO SIZE WITH THE SCALE CHECK. WITH A RULER, CHECK IF THE TWO LINES ARE 3CM AND 3 INCHES AS INDICATED.

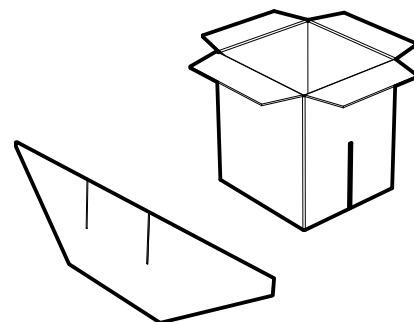
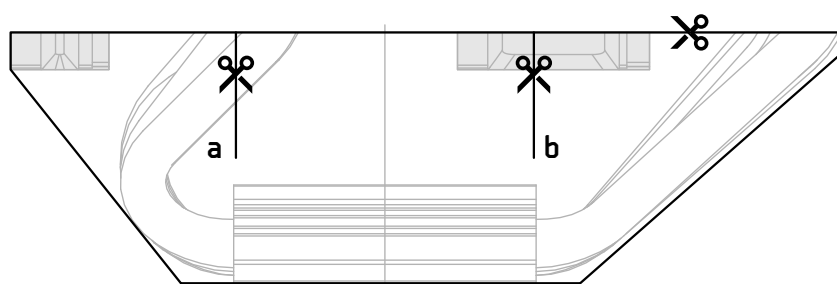
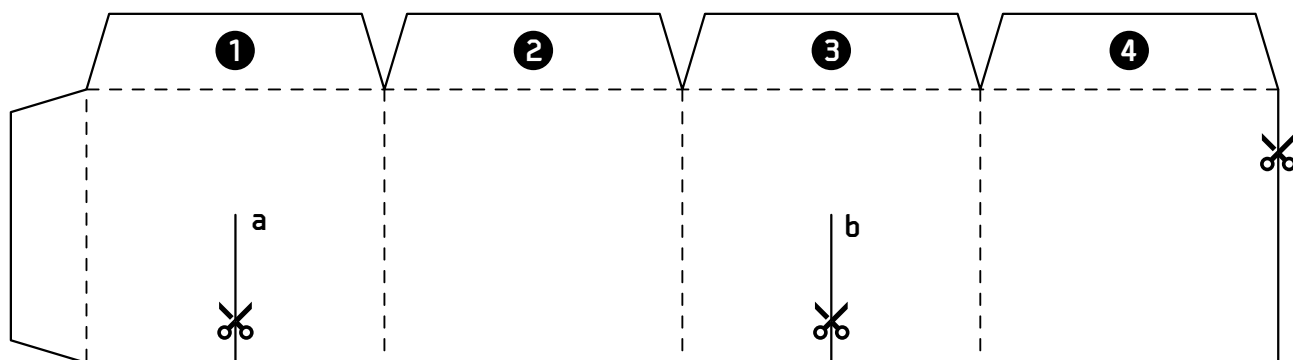
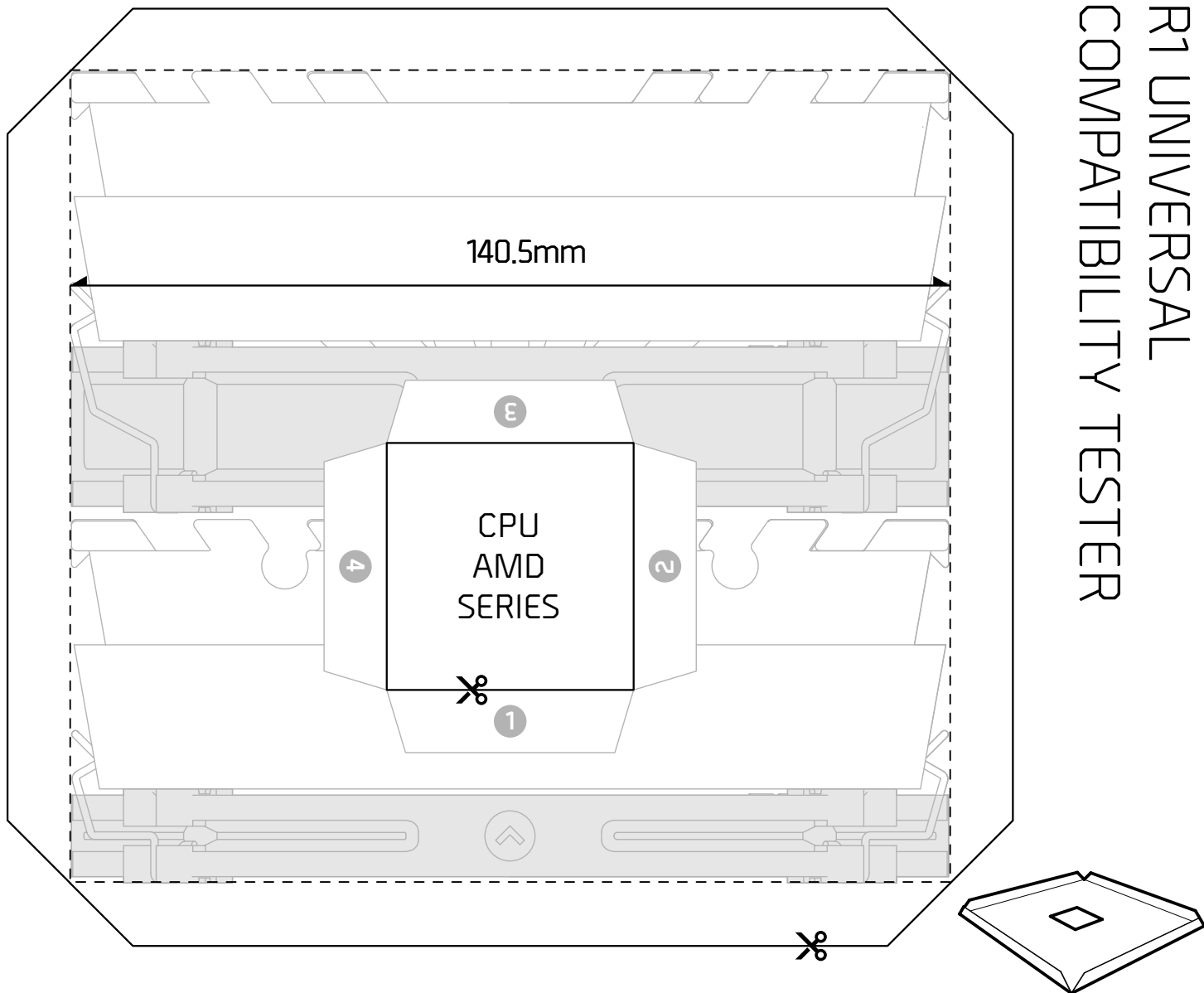
R1 UNIVERSAL COMPATIBILITY TESTER

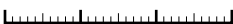

Scale Check Zone :  3 cm  3 inch



CHECK IF YOUR PRINT IS TRUE TO SIZE WITH THE SCALE CHECK. WITH A RULER, CHECK IF THE TWO LINES ARE 3CM AND 3 INCHES AS INDICATED.